

K O N A R

USER MANUAL / UPUTE ZA UPORABU REFRIGERATOR / HLADNJAK

HC60293NFINVBH/HC60293NFINVIH

PROIZVOĐAČ:
KONČAR - KUĆANSKI APARATI d.d.
Karlovačka ulica 23, 10451 Pisarovina, Hrvatska, EU
T: + (385) 1 2484 555 F: + (385) 1 2404 102
kucanski@koncar-ka.hr www.koncar-ka.hr
Zemlja porijekla: Kina

Content	
1. Safety Information	Page 1~11
2. Product description	Page 12
3. Installation	Page 13~14
4. Reverse Door	Page 15~18
5. Control panel	Page 19~21
6. Daily use	Page 22~25
7. Environment Protection	Page 26~27

SAFETY INFORMATIONS!

Before first use

In the interest of your safety and to ensure the correct use, before installing and first using the appliance, read this user manual carefully, including its hints and warnings. To avoid unnecessary mistakes and accidents, it is important to ensure that all people using the appliance are thoroughly familiar with its operation and safety features. Save these instructions and make sure that they remain with the appliance if it is moved or sold, so that everyone using it through its life will be properly informed on appliance use and safety. For the safety of life and property keep the precautions of these user's instructions as the manufacturer is not responsible for damages caused by omission.

Children and vulnerable people safety

- This appliance can be used by children

aged from 8 years and above and persons with reduced physical, sensory or mental capabilities or lack of experience and knowledge if they have been given supervision or instruction concerning use of the appliance in a safe way and understand the hazards involved.

- Children aged from 3 to 8 to years are allowed to load and unload this appliance.
- Children should be supervised to ensure that they do not play with the appliance.
- Leaning and user maintenance shall not be made by children unless they are aged from 8 years and above and supervised.
- If you are discarding the appliance pull the plug out of the socket, cut the connection cable (as close to the appliance as you can) and remove the door to prevent playing children to suffer electric shock or to close themselves into it.

- If these appliance featuring magnetic door seals is to replace an older appliance having a spring lock (latch) on the door or lid, be sure to make that sprig lack unusable before you discard the old appliance. This will prevent it from becoming a death trap for a child.

General safety



WARNING! Keep ventilation openings, in the appliance enclosure or in the built in structure, clear of obstruction.



WARNING! Do not use mechanical devices or other means to accelerate the defrosting process, other than those recommended by the manufacturer.





WARNING! Do not damage the refrigerant circuit.



WARNING! Do not use other electrical appliances such as ice cream

makers inside of refrigerating appliances, unless they are approved for this purpose by the manufacture.

 **WARNING!** Do not touch the light bulb if it has been on for a long period of the time could be very hot.

 **WARNING!** When positioning the appliance, ensure the supply cord is not trapped or damaged.

 **WARNING!** Do not locate multiple portable socket-outlets or portable power suppliers at the rear of the appliance.

1. Do not store explosive substance such as aerosol cans with a flammable propellant in this appliance.

2. The refrigerant isobutene (R-600a) is contained within the refrigerant circuit of the appliance, a natural gas with a high level of environmental compatibility, which is nevertheless flammable.

3. During transportation and installation of the appliance, be certain that none of the components of the relevant circuit become damaged.

- Avoid open flames and sources of ignition
- Thoroughly ventilate the room in which the appliance is situated

4. It is dangerous to alter the specifications or modify this product in any way. Any damage to the cord may cause a short circuit, fire and/or electric shock.

5. This appliance is intended to be used in household and similar applications such as: staff kitchen areas in shops, offices and other working environments

6. farm houses and by clients in hotels, motels and other residential type of environments

7. bed and breakfast type of environments

8. catering and similar non-retail applications

 **WARNING!** Any electrical components plug, power cord, compressor and

etc. must be replaced by a certified service agent or qualified service personnel.

 **WARNING!** The light bulb supplied with this appliance is a “special use lamp bulb” usable only with the appliance supplied. This “special use lamp” is not usable for domestic lighting.

- Power cord must not be lengthened
- Make sure that the power plug is not squashed or damaged by the back of the appliance. A squashed or damaged power plug may overheat and cause a fire.
- Make sure that you can come to the mains plug of the appliance.
- Do not pull the mains cable
- If the power plug socket is loose, do not insert the power plug. There is a risk of electric shock or fire.
- You must not operate the appliance without the lamp.
- This appliance is heavy. Care should be taken when moving it.

- Do not remove not touch items from the freezer compartment if your hands are damp/wet, as this could cause skin abrasions or frost/freezer burns.
- Avoid prolonged exposure of the appliance to direct sunlight.

Daily use

- Do not put hot on the plastic parts in the appliance.
- Do not place food products directly against the rear wall
- Frozen food must not be refrozen once it has been thawed out.
- Store pre packed frozen food in accordance with the frozen food manufacture's instructions
- Appliance's manufactures storage
- recommendations should be strictly adhered to. Refer to relevant instructions.
- Do not place carbonated or fizzy drinks in the freezer compartment as it creates pressure on the container, which may cause it to explode, resulting in damage to the appliance.

- Ice lollies can cause frost burns if consumed straight from the appliance.
- To avoid contamination of food, please respect the following instructions
- Opening the door for long periods can cause a significant increase of the temperature in the compartments of the appliance.
- Clean regularly surfaces that can come in contact with food and accessible drainage systems.
- Clean water tanks if they have not been used for 48h; flush the water system connected to a water supply if water has not been drawn for 5 days.
- Store raw meat and fish in suitable containers in the refrigerator, so that it is not in contact with or drip onto other food.
- Two-star frozen-food compartments (if they are presented in the appliance) are suitable for storing pre-frozen food, storing or making ice-cream and making ice cubes.
- One-, two- and three - star compartments (if they are presented in the appliance) are not suitable for the freezing of fresh food)

- If the appliance is left empty for long periods, switch off, defrost, clean, dry and leave the door open to prevent mould developing within the appliance.

Care and cleaning

- Before maintenance, switch off the appliance and disconnect the mains plug from the mains socket.

- Do not clean the appliance with metal objects.

- Do not use sharp objects to remove frost from the appliance. Use a plastic scraper.

- Regularly examine the drain in the refrigerator for defrosted water. If necessary, clean the drain. If the drain is blocked, water will collect in the bottom of the appliance.

Installation

Important! For electrical connection carefully follow the instructions given in specific paragraphs.

- Unpack the appliance and check if there are damages on it. Do not connect the appliance if it is damaged. Report possible damages immediately to the place you bought it. In that case retain packing.
- It is advisable to wait at least four hours before connecting the appliance to allow the oil to flow back in the compressor.
- Adequate air circulation should be around the appliance, lacking this leads to overheating. To achieve sufficient ventilation follow the instructions relevant to installation.

- Wherever possible the spacers of the product should be against a wall to avoid touching or catching warm parts (compressor, condenser) to prevent possible burn.
- The appliance must not be located close to radiators or cookers.
- Make sure that the mains plug is accessible after the installation of the appliance.

Service

- Any electrical work required to do the servicing of the appliance should be carried out by a qualified electrician or competent person.
- This product must be serviced by an authorized Service center, and only genuine spare parts must be used.

Energy saving

- Don't put hot food in the appliance
- Don't pack food close together as this prevents air-circulating
- Make sure food don't touch the back of the compartment(s)
- If electricity goes off, don't open the door(s)
- Don't open the door (s) frequently
- Don't keep the door (s) open for too long time
- Don't set the thermostat on exceeding cold temperatures
- All accessories, such as drawers, shelves balconies, should be kept there for lower energy consumption.

PRODUCT DESCRIPTION

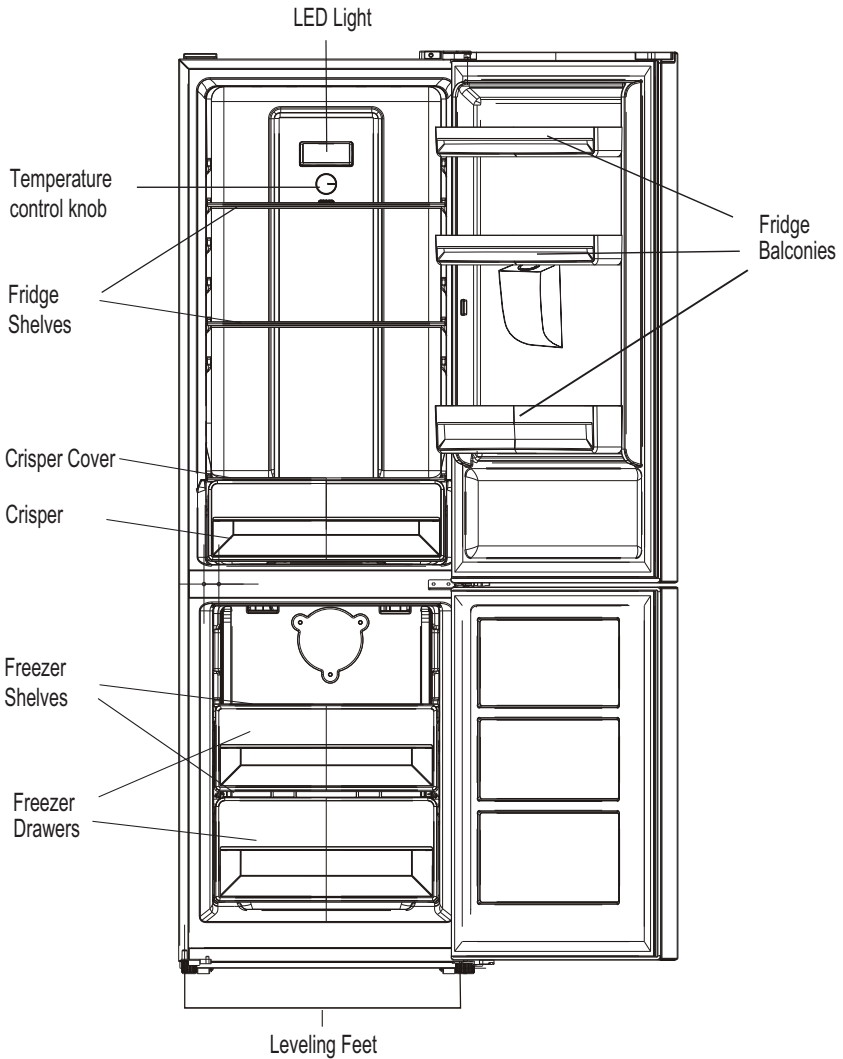

Note: Above picture is for reference only. Real appliance probably is different.

Installation

Install door external handle (if external handle present)

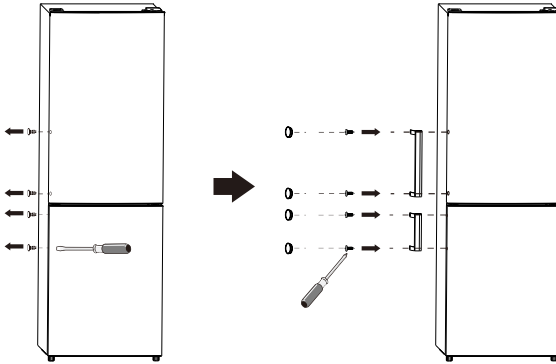

Space requirement

- Keep enough space of door open.

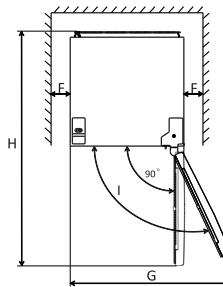
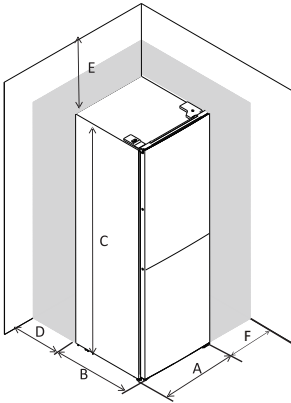

A	600
B	605
C	1860
D	min=50
E	min=50
F	min=50
G	1200
H	1200
I	135°

Levelling the unit

To do this adjust the two levelling feet at front of the unit.

If the unit is not level, the doors and magnetic seal alignments will not be covered properly.

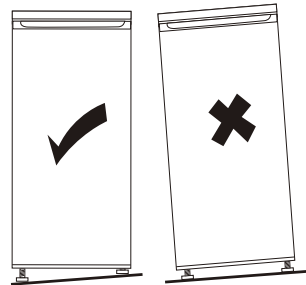
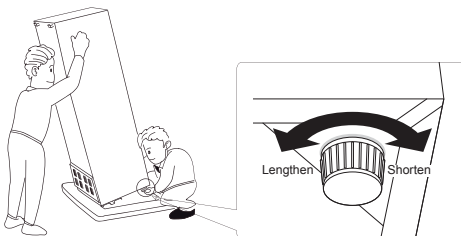

INSTALLATION

Space Requirement

- Select a location without direct exposure to sunlight;
- Select a location with enough space for the refrigerator doors to open easily;
- Select a location with level (or nearly level) flooring;
- Allow sufficient space to install the refrigerator on a flat surface;
- Allow clearance to the right, left, back and top when installing. This will help reduce power consumption and keep your energy bills lower.
- Keep at least 50mm gap at two sides and back.

• this refrigerating appliance is not intended to be used as a built-in appliance

Positioning Install this appliance at a location where the ambient temperature corresponds to the climate class indicated on the rating plate of the appliance:

for refrigerating appliances with climate class:

- extended temperate: this refrigerating appliance is intended to be used at ambient temperatures ranging from 10 °C to 32 °C;(SN)

- temperate: this refrigerating appliance is intended to be used at ambient temperatures ranging from 16 °C to 32 °C;(N)

- subtropical: this refrigerating appliance is intended to be used at ambient temperatures ranging from 16 °C to 38 °C;(ST)

- tropical: this refrigerating appliance is intended to be used at ambient temperatures ranging from 16 °C to 43 °C;(T)

Location

The appliance should be installed well away from sources of heat such as radiators, boilers, direct sunlight etc. Ensure that air can circulate freely around the back of the cabinet. To ensure best performance, if the appliance is positioned below an overhanging wall unit, the minimum distance between the top of the cabinet and the wall unit must be at least 100 mm. Ideally, however, the appliance should not be positioned below overhanging wall units. Accurate leveling is ensured by one or more adjustable feet at the base of the cabinet.

Warning! It must be possible to disconnect the appliance from the mains power supply; the plug must therefore be easily accessible after installation.



Electrical connection

Before plugging in, ensure that the voltage and frequency shown on the rating plate correspond to your domestic power supply. The appliance must be earthed. The power supply cable plug is provided with a contact for this purpose. If the domestic power supply socket is not earthed, connect the appliance to a separate earth in compliance with current regulations, consulting a qualified electrician. The manufacturer declines all responsibility if the above safety precautions are not observed. This appliance complies with the E.E.C. Directives.

Door Reversibility

Before reversing the door, please be prepared below tools and material: straight screwdriver, cross screwdriver, spanner and the components included in the poly bag:

Left Door Hinge Cover x 1

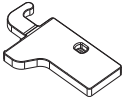

Left Aid-Closer on Upper Door x 1

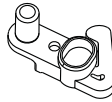

Left Aid-Closer on Lower Door x 1

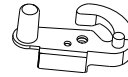

1. Unscrew top hinge cover and then unscrew the top hinge .
Then lift upper door and place it on a soft pad to avoid scratch and damage.

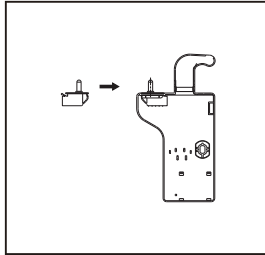
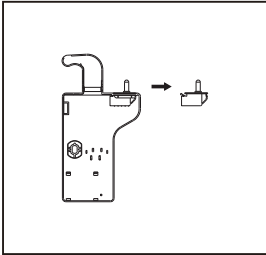
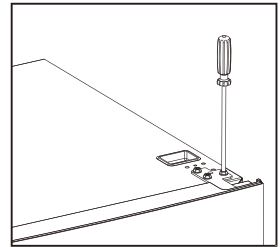
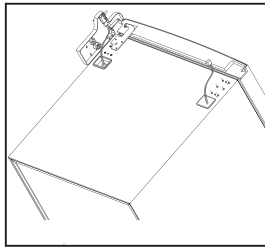
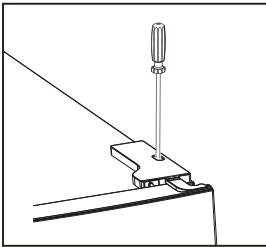

2. Remove the top left screw cover.

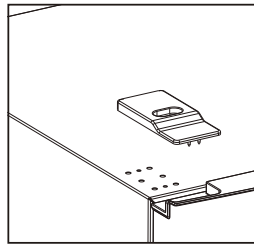
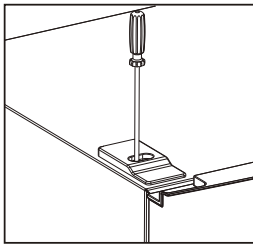

3. Take off the upper door, take out the screw from the middle hinge by cross screwdriver, then take off the lower door.

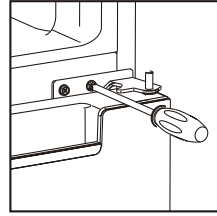

4. Laying down the refrigerator, take out the adjusting feet as below, then take off the lower hinge by cross screwdriver.

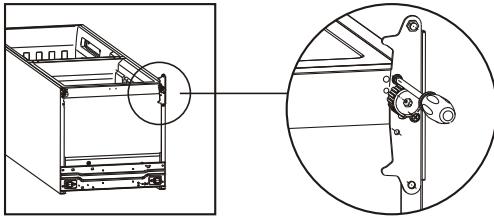

5. Adjusting the hinge core position of the lower hinge and upper hinge to opposite position

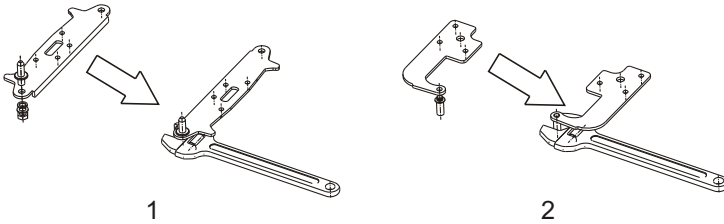

6. Install the lower hinge under to the refrigerator like below, screwing in the adjusting feet, make sure the position in horizon.

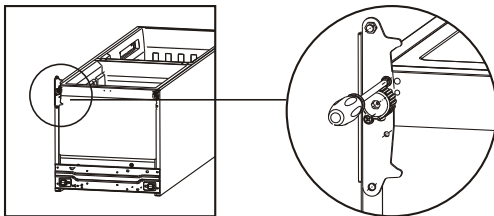

7. Remove the original aid-closers from upper and lower door, then install the aid-closers from the internal bag (with instruction manuals) to the opposite side.

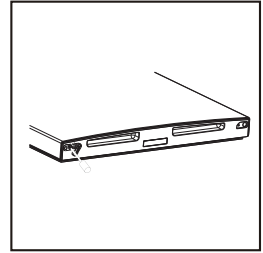
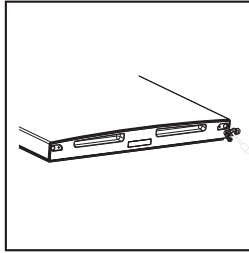

8. Install the lower door, adjust and fix the middle hinge onto the cabinet.

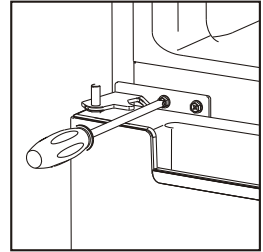

9. Place the upper door back on. Ensure the door is aligned horizontally and vertically so that the seal are closed on all sides before finally tightening the top hinge. Then insert the top hinge and screw it to the top of unit and then fix hinge cover (in accessory bag) by screw.

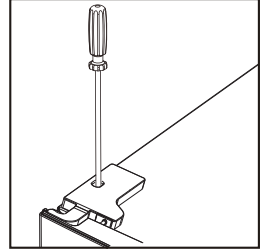
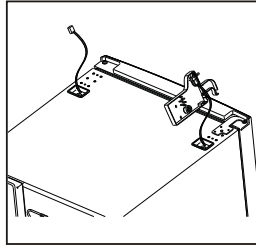
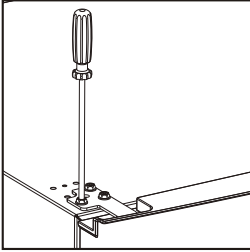

10. Fix the screw cover.

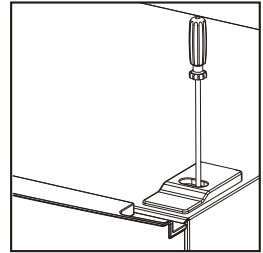

11. Detach the Fridge and the Freezer door gaskets and then attach them after rotating.

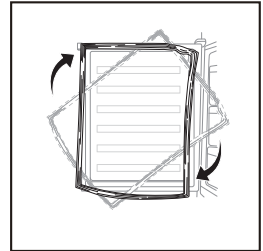

CONTROL PANEL

1. Temperature setting of the fridge compartment

The fridge temperature setting knob

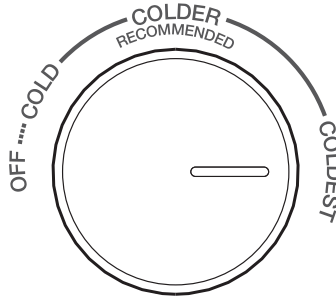

- The knob in fridge compartment is used to adjust temperature of fridge compartment.
- The internal temperature is controlled by a sensor. There are 4 settings: OFF, COLD, COLDER and COLDEST. COLD is warmest setting and COLDEST is coldest setting.
- The appliance may not operate at the correct temperature if it is in a particularly hot or if you open the door often.
- Neither fridge, nor freezer compartment works when the setting is OFF.

2. Temperature setting of the freezer compartment

The freezer temperature setting slider

FREEZER CONTROL

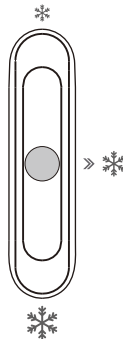

- This slider in fridge compartment is used to adjust temperature of freezer compartment.
- Slider is positioned toward ❄️, the temperature in freezer compartment will be higher. Contrarily, the temperature in freezer compartment will be lower if the slider is moved toward ❄️.
- Middle position ❄️ of slider is advised position for normal using.
- To get lowest temperature in freezer compartment, you can adjust setting knob at coldest and position the slider at ❄️.

3. Temperature setting recommendaton

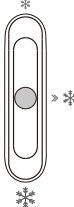
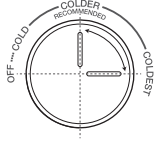
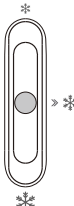
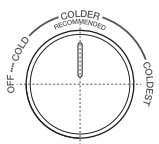
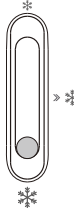
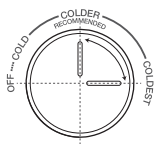
Temperature Setting Recommendation		
Environment Temperature	Freezer compartment	Fridge compartment
Summer (Above 38°C)		Set on *
		 Set on colder~coldest
Normal		Set on *
		 Set on colder
Winter (Below 16°C)		Set on *
		 Set on colder~coldest

- Information above give users recommendation of temperature setting.
- In winter or temperature below 16°C, users should avoid set on * and cold.
- For energy saving, the ❄️ and coldest set only apply to special need(such as quick-freezing or ice making), and need turn back after special need.

**HC60293NFIDH/HC60293NFBBDH
HC60293NFINVIDH/HC60293NFINVBDH**

Before using the water dispenser for the first time, remove and clean the water tank located inside the refrigeration compartment

1. Lift and remove the tank balcony.

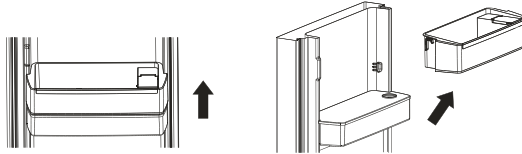

2. Remove the water tank. Detach the top cover and wash and clean both the tank and the cover.

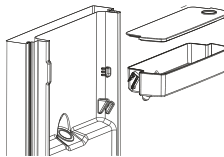

3. After cleaning, reposition water tank, cover and tank balcony as below:

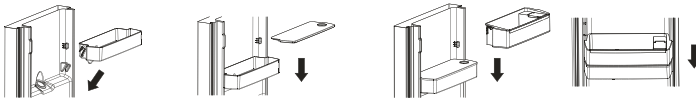

4. Clean the dispenser lever outside the refrigerator door.

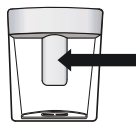

Filing the water tank

1. Open the small lid in the top of the tank balcony.
2. Fill the water tank with drinkable water up to the 2L line.
3. Close the lid. Ensure it is firmly shut.

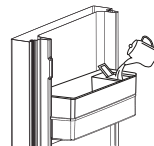

Dispensing water

- Push the dispenser lever gently with a glass or container.
To stop the flow, pull the glass away from the lever.



First use

Cleaning the interior

Before using the appliance for the first time, wash the interior and all internal accessories with lukewarm water and some neutral soap so as to remove the typical smell of a brand new product, then dry thoroughly.

Important! Do not use detergents or abrasive powders, as these will damage the finish.

Daily use

Position different food in different compartments according to be below table

Refrigerator compartments	Type of food
Door or balconies of fridge compartment	<ul style="list-style-type: none">• Foods with natural preservatives, such as jams, juices, drinks, condiments.• Do not store perishable foods.
Crisper drawer (salad drawer)	<ul style="list-style-type: none">• Fruits, herbs and vegetables should be placed separately in the crisper bin.• Do not store bananas, onions, potatoes, garlic in the refrigerator.
Fridge shelf – middle	<ul style="list-style-type: none">• Dairy products, eggs
Fridge shelf – top	<ul style="list-style-type: none">• Foods that do not need cooking, such as ready-to-eat foods, deli meats, leftovers.
Freezer drawer(s)/shelf	<ul style="list-style-type: none">• Foods for long-term storage.• Bottom drawer/shelf for raw meat, poultry, fish.• Middle drawer/shelf for frozen vegetables, chips.• Top drawer/shelf for ice cream, frozen fruit, frozen baked goods.

Freezing fresh food

- The freezer compartment is suitable for freezing fresh food and storing frozen and deep-frozen food for a long time.
- Place the fresh food to be frozen in the bottom compartment.
- The maximum amount of food that can be frozen in 24 hours is specified on the rating plate.
- The freezing process lasts 24 hours: during this period do not add other food to be frozen.

Storing frozen food

When first starting-up or after a period out of use. Before putting the product in the compartment let the appliance run at least 2 hours on the higher settings.

Important! In the event of accidental defrosting, for example the power has been off for longer than the value shown in the technical characteristics chart under "rising time", the defrosted food must be consumed quickly or cooked immediately and then re-frozen (after cooked).

Thawing

Deep-frozen or frozen food, prior to be used, can be thawed in the freezer compartment or at room temperature, depending on the time available for this operation.

Small pieces may even be cooked still frozen, directly from the freezer. In this case, cooking will take longer.

Accessories

Movable shelves

The walls of the refrigerator are equipped with a series of runners so that the shelves can be positioned as desired.

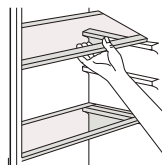

Positioning the door balconies

Door balconies can be disassembled for cleaning. To make the disassembling as follows: gradually pull the balcony in the direction of the arrows until it comes free, after cleaning, reposition it.



Disassemble the bottom drawer

1. Pull out the bottom drawer to stopper position.
2. Lift up the front of drawer
3. Pull out the bottom drawer.

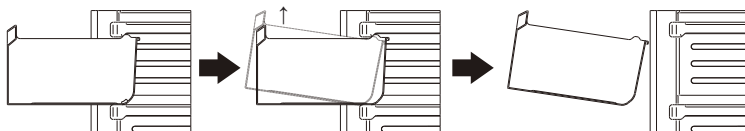

Helpful hints and tips

Hints for freezing

To help you make the most of the freezing process, here are some important hints :

- the maximum quantity of food which can be frozen in 24 hrs. is shown on the rating plate;
- the freezing process takes 24 hours. No further food to be frozen should be added during this period;
- only freeze top quality, fresh and thoroughly cleaned, foodstuffs;
- prepare food in small portions to enable it to be rapidly and completely frozen and to make it possible subsequently to thaw only the quantity required;
- wrap up the food in aluminium foil or polythene and make sure that the packages are airtight;
- do not allow fresh, unfrozen food to touch food which is already frozen, thus avoiding a rise in temperature of the latter;
- lean foods store better and longer than fatty ones; salt reduces the storage life of food;
- water ices, if consumed immediately after removal from the freezer compartment, can possibly cause the skin to be freeze burnt;
- it is advisable to show the freezing in date on each individual pack to enable you removal from the freezer compartment, can possibly cause the skin to be freeze burnt;
- it is advisable to show the freezing in date on each individual pack to enable you to keep tab of the storage time.

Hints for storage of frozen food

To obtain the best performance from this appliance, you should: make sure that the commercially frozen foodstuffs were adequately stored by the retailer; be sure that frozen foodstuffs are transferred from the food store to the freezer in the shortest possible time;

not open the door frequently or leave it open longer than absolutely necessary.

Once defrosted, food deteriorates rapidly and cannot be refrozen.

Do not exceed the storage period indicated by the food manufacture.

Hints for fresh food refrigeration

To obtain the best performance:

- Do not store warm food or evaporating liquids in the refrigerator
- Do cover or wrap the food, particularly if it has a strong flavour

Hints for refrigeration

Useful hints:

- Make (all types): wrap in polythene bags and place on the glass shelves above the vegetable drawer.
- For safety, store in this way only one or two days at the most.
- Cooked foods, cold dishes, etc...: these should be covered and may be placed on any shelf.
- Fruit and vegetables: these should be thoroughly cleaned and placed in the special drawer(s) provided.
- butter and cheese: these should be placed in special airtight containers or wrapped in aluminum foil or polythene bags to exclude as much air as possible.
- Milk bottle: these should have a cap and should be stored in the balconies on the door.
- Bananas, potatoes, onions and garlic, if not packed.
- For energy efficiency, all drawers, baskets and shelves, must be in right place, must not be kept in the fridge.

Cleaning

For hygienic reasons the appliance interior, including interior accessories, should be cleaned regularly.



Caution! The appliance may not be connected to the mains during cleaning. Danger of electrical shock! Before cleaning switch the appliance off and remove the plug from the mains, or switch off or turn out the circuit breaker or fuse. Never clean the appliance with a steam cleaner. Moisture could accumulate in electrical components, danger of electrical shock! Hot vapors can lead to the damage of plastic parts. The appliance must be dry before it is placed back into service.

Important! Ethereal oils and organic solvents can attack plastic parts, e.g. lemon juice or the juice from orange peel, butyric acid, cleanser that contain acetic acid.

- Do not allow such substances to come into contact the appliance parts.
- Do not use any abrasive cleaners
- Remove the food from the freezer. Store them in a cool place, well covered.
- Switch the appliance off and remove the plug from the mains, or switch off or turn out the circuit breaker of fuse.
- Clean the appliance and the interior accessories with a cloth and lukewarm water. After cleaning wipe with fresh water and rub dry.
- After everything is dry place appliance back into service.

Replace the lamp

The internal light is a LED type. To replace the lamp, please contact qualified technician.

Troubleshooting



Caution! Before troubleshooting, disconnect the power supply. Only a qualified electrician or competent person must do the troubleshooting that is not in this manual.

Important! There are some sounds during normal use (compressor, refrigerant circulation).

Problem	Possible cause	Solution
Appliance does not work	Temperature regulation knob is set at coldest	Set the knob at other switch on the appliance.
	Mains plug is not plugged in or is loose	Insert mains plug.
	Fuse has blown or is defective	Check fuse, replace if necessary.
	Socket is defective	Mains malfunctions are to be corrected by an electrician.
Appliance freezes or cools too much	Temperature is set too cold or the appliance runs at coldest.	Turn the temperature regulator to a warmer setting temporarily.
The food is not frozen enough.	Temperature is not properly adjusted.	Please look in the initial Temperature Setting section.
	Door was open for an extended period.	Open the door only as long as necessary.
	A large quantity of warm food was placed in the appliance within the last 24 hours.	Turn the temperature regulation to a colder setting temporarily.
	The appliance is near a heat source.	Please look in the installation location section.
Heavy build up of frost on the door seal.	Door seal is not air tight.	Carefully warm the leaking sections of the door seal with a hair dryer (on a cool setting). At the same time shape the warmed door seal by hand such that it sits correctly.
Unusual noises	Appliance is not level.	Re-adjust the feet.
	The appliance is touching the wall or other objects.	Move the appliance slightly.
	A component, e.g. a pipe, on the rear of the appliance is touching another part of the appliance or the wall.	If necessary, carefully bend the component out of the way.
Water on the floor	Water drain hole is blocked.	See the Cleaning and Care section.
Side panels are hot.	It's normal. Heat exchange parts are in the sides.	Take gloves to touch sides if needed.

If the malfunction shows again, contact the Service Center.

These data are necessary to help you quickly and correctly. Write the necessary data here, refer to the rating plate.

Environment Protection

This appliance does not contain gasses which could damage the ozone layer, in either its refrigerant circuit or insulation materials. The appliance shall not be discarded together with the urban refuse and rubbish. The insulation foam contains flammable gases: the appliance shall be disposed according to the appliance regulations to obtain from your local authorities. Avoid damaging the cooling unit, especially the heat exchanger.

The materials used on this appliance marked by the symbol  are recyclable.



The symbol on the product or on its packaging indicates that this product may not be treated as household waste. Instead it should be taken to the appropriate collection point for the recycling of electrical and electronic equipment. By ensuring this product is disposed of correctly, you will help prevent potential negative consequences for the environment and human health, which could otherwise be caused by inappropriate waste handling of this product. For more detailed information about

recycling of this product, please contact your local council, your household waste disposal service or the shop where you purchased the product.

Packaging materials

The materials with the symbol are recyclable.
Dispose the packaging in a suitable collection containers to recycle it.

Disposal of the appliance

1. Disconnect the mains plug from the mains socket.
2. Cut off the mains cable and discard it.



WARNING! During using, service and disposal the appliance, please pay attention to symbol similar as left side, which is located on rear appliance (rear panel or compressor) and with yellow or orange color. If the risk of fire warning symbol. There are flammable materials in refrigerant pipes and compressor. Please be far away fire source during using, service and disposal.

Sadržaj	
1. Sigurnosne informacije	Stranica 1~9
2. Opis proizvoda	Stranica 10
3. Instalacija uređaja	Stranica 11~12
4. Promjena smjera otvaranja vrata	Stranica 13~16
5. Svakodnevna uporaba	Stranica 17~19
6. Otklanjanje kvarova	Stranica 20~23
7. Zbrinjavanje uređaja	Stranica 24~25

UPOZORENJA I SIGURNOSNE INFORMACIJE

Prije prve uporabe

Za vašu sigurnost i pravilnu uporabu, prije postavljanja i uporabe uređaja, pažljivo pročitajte ove upute zajedno sa savjetima i upozorenjima. Kako biste izbjegli nepotrebne pogreške i nezgode, važno je da sve osobe koje koriste uređaj budu upoznate s njegovim načinom rada i sigurnosnim značajkama. Spremite ove upute kako bi drugi mogli koristiti uređaj i upoznati se s korištenjem i mjerama sigurnosti ako ga poklonite ili prodate.

Radi sigurnosti ljudi, životinja i imovine, pridržavajte se mjera opreza u ovim uputama jer proizvođač ne odgovara za štete nastale uslijed njihova nepridržavanja.

Sigurnost djece i nemoćnih osoba

Uređaj mogu upotrebljavati djeca od 8 godina nadalje i osobe smanjenih psihofizičkih, osjetilnih ili mentalnih sposobnosti ili s nedovoljnim iskustvom i znanjem, ukoliko im je pružen nadzor ili upute vezane za uporabu uređaja na siguran način te ako razumiju moguću opasnost koja je prisutna pri uporabi. Ne

dozvolite djeci igranje s uređajem. Djeca ne smiju čistiti ili održavati ovaj uređaj bez nadzora.

Djeca u dobi između 3 i 8 godina smiju puniti i prazniti hladnjak.

Uređaj nije namijenjen uporabi od strane osoba (i djece) smanjenih fizičkih, osjetilnih ili mentalnih sposobnosti ili s manjkom znanja i iskustva, osim ako nisu pod nadzorom osobe zadužene za njihovu sigurnost. Nadzirajte djecu kako se ne bi igrala uređajem.

Ambalažu držite dalje od djece jer predstavlja opasnost od gušenja.

Prilikom zbrinjavanja dotrajalog uređaja, odspojite kabel napajanja iz utičnice i odrežite ga na mjestu što bliže uređaju te skinite vrata kako se djeca ne bi slučajno zatvorila unutra i doživjela strujni udar.

Ako ovaj uređaj s magnetskim brtvama vrata zamjenjuje stariji s opružnom bravom na vratima ili poklopcu, onesposobite je prije zbrinjavanja starog uređaja. To će spriječiti fatalne posljedice do kojih može doći ako se unutra zaključaju djeca.

Opće sigurnosne informacije

Ventilacijski otvori uređaja moraju biti slobodni, bez blokada.

Ne upotrebljavajte mehanička sredstva ili druga umjetna sredstva za odleđivanje koja nisu preporučena od strane proizvođača.

Ne oštećujte sklop rashladnog sustava.

Ne upotrebljavajte električne uređaje u odjeljcima za spremanje hrane, kao što je ledomat, osim ako ih nije preporučio proizvođač.

Ne dirajte svjetlo u hladnjaku jer bi moglo biti vruće. Iza uređaja nemojte postavljati višestruke utičnice ili prijenosne izvore napajanja.

Prilikom postavljanja uređaja, pazite da kabel napajanja ne bude priklješten ili oštećen.

U uređaju nemojte držati eksplozivne tvari poput raspršivača sa zapaljivim plinovima.

Rashladni sklop uređaja sadrži rashladni plin izobutan (R600a), prirodni plin koji ne zagađuje okoliš, ali je zapaljiv. Provjerite da tijekom transporta i postavljanja uređaja nije došlo do oštećenja nijedne komponente rashladnog sklopa.

Rashladni plin (R600a) je zapaljiv.

Hladnjaci u izolacijskim materijalima sadrže rashladna sredstva i plinove. Rashladno sredstvo i plinovi moraju se zbrinuti na profesionalan način jer mogu izazvati ozljede očiju ili zapaljenje. Pazite da prije zbrinjavanja cijevi rashladnog sredstva nisu oštećene.

Ako je rashladni sklop oštećen:

- Izbjegavajte otvoreni plamen i izvore zapaljenja.
- Dobro prozračite prostoriju u kojoj se uređaj nalazi.

Opasno je mijenjati karakteristike uređaja ili ga modificirati na bilo koji način.

Bilo kakvo *oštećenje* kabela napajanja može izazvati kratak spoj, požar i/ili strujni udar.

Ovaj uređaj je namijenjen uporabi u kućanstvima i:

- kuhinjama za osoblje u trgovinama, uredima i drugim radnim okruženjima;
- u kućama na poljoprivrednim dobrima, za goste u hotelima, motelima i sličnim vrstama smještaja;
- u prenoćištim;
- u cateringu i drugim uslugama s prodajom na veliko

Kabel napajanja ne smije se produljivati.

Pazite da utikač kabela nije oštećen ili polomljen. Oštećeni ili polomljen utikač može se pregrijati i izazvati požar.

Priključnica napajanja uređaja uvijek mora biti lako dostupna.

Nemojte povlačiti kabel.

Ako je strujna utičnica labava, nemojte u nju spajati kabel napajanja. Postoji rizik od strujnog udara ili požara.

Žarulja u uređaju ne smije se koristiti bez njezina poklopca.

Svakodnevna uporaba

1. U uređaju nemojte pohranjivati zapaljive plinove ili tekućine. Postoji opasnost od eksplozije.
2. U uređaju nemojte koristiti nikakve električne uređaje (npr. električne aparate za sladoled, miksera i sl.).
3. Prilikom odspajanja uređaja iz napajanja, uvijek povlačite utikač, a ne sâm kabel.
4. Blizu plastičnih dijelova uređaja nemojte stavljati vruće predmete.
5. Nemojte stavljati namirnice direktno na odvod zraka na stražnjoj stjenci.

6. Zamrznuta jela čuvajte u skladu s uputama proizvođača.
7. Valja se strogo pridržavati uputa proizvođača o čuvanju namirnica. Pročitajte važeće upute za pohranjivanje.
8. U zamrzivač ne stavljajte gazirana pića jer ona stvaraju pritisak u bocama/limenkama te mogu eksplodirati i oštetiti uređaj.
9. Zamrznuta hrana može izazvati ozeblina ako je konzumirate direktno iz zamrzivača.
10. Ne postavljajte uređaj izravno sunce.
11. Upaljene svijeće, svjetiljke i izvore otvorenog plamena držite dalje od uređaja kako se ne bi zapalio.
12. Uređaj je namijenjen čuvanju hrane i/ili pića u kućanstvima, kao što je opisano u ovim uputama. Uređaj je težak. Budite pažljivi prilikom njegova pomicanja.
13. Nemojte vaditi ili dirati namirnice u zamrzivaču vlažnim/mokrim rukama jer to može izazvati abrazije kože ili ozeblina.
14. Postolje, ladice, vrata itd. nemojte koristiti za stajanje ili podupiranje.
15. Jednom odmrznute namirnice ne smiju se ponovno zamrzavati.

16. Nemojte konzumirati sladolede ili kocke leda izravno iz zamrzivača jer to može izazvati ozeblina na ustima.
17. Kako biste izbjegli padanje predmeta i ozljede ili oštećenja uređaja, nemojte pretrpavati police u vratima ili ladice.

Oprez! Održavanje i čišćenje

Prije održavanja isključite uređaj i odspojite kabel napajanja iz utičnice.

Nemojte čistiti uređaj metalnim predmetima, parnim strojevima, eteričnim uljima, organskim otapalima ili abrazivnim sredstvima.

Nemojte uklanjati led oštrim predmetima. Upotrijebite plastičnu strugalicu.

Instalacija – važno!

Pridržavajte se ovdje navedenih uputa za električno povezivanje.

- Raspakirajte uređaj i provjerite je li oštećen. Ako je uređaj oštećen, nemojte ga koristiti. Moguća

oštećenja odmah prijavite prodavatelju. U tom slučaju sačuvajte ambalažu.

- Prije spajanja na napajanje savjetuje se pričekati najmanje četiri sata kako bi se ulje vratilo u kompresor.
- Oko uređaja ostavite dovoljno prostora za ventilaciju jer se u suprotnom može pregrijati. Za dostatnu ventilaciju, slijedite upute o instalaciji.
- Kad god je moguće, stražnja stjenka uređaja ne smije biti preblizu zidu kako ne bi došlo do kontakta s toplim dijelovima (kompresor, kondenzator), jer postoji rizik od požara. Slijedite upute o instalaciji.
- Uređaj ne smije biti blizu radijatora ili štednjaka.
- Vodite računa da nakon postavljanja uređaja utikač kabela napajanja bude lako dostupan.

Sve radove vezane uz struju prepustite stručnom električaru ili kvalificiranoj osobi.

Ovaj uređaj treba servisirati u ovlaštenom servisu i moraju se koristiti samo originalni rezervni dijelovi.

Ušteda energije

Savjetujemo da slijedite donje savjete kako biste uštedjeli energiju.

- Pokušajte izbjegavati predugo otvaranje vrata.
- Odmaknite uređaj od bilo kakvih izvora topline (direktno sunce, električna pećnica ili štednjak itd.).
- Nemojte podešavati nižu temperaturu nego što je potrebno.
- U hladnjak nemojte stavljati topla jela ili tekućine koje isparavaju.
- Postavite uređaj dobro ventiliranu prostoriju bez vlage. Pogledajte odjeljak "Postavljanje vašeg novog uređaja".
- Ako dijagram prikazuje pravilnu kombinaciju ladica i polica, nemojte je mijenjati jer je ta kombinacija energetske najefikasnija.

OPIS PROIZVODA

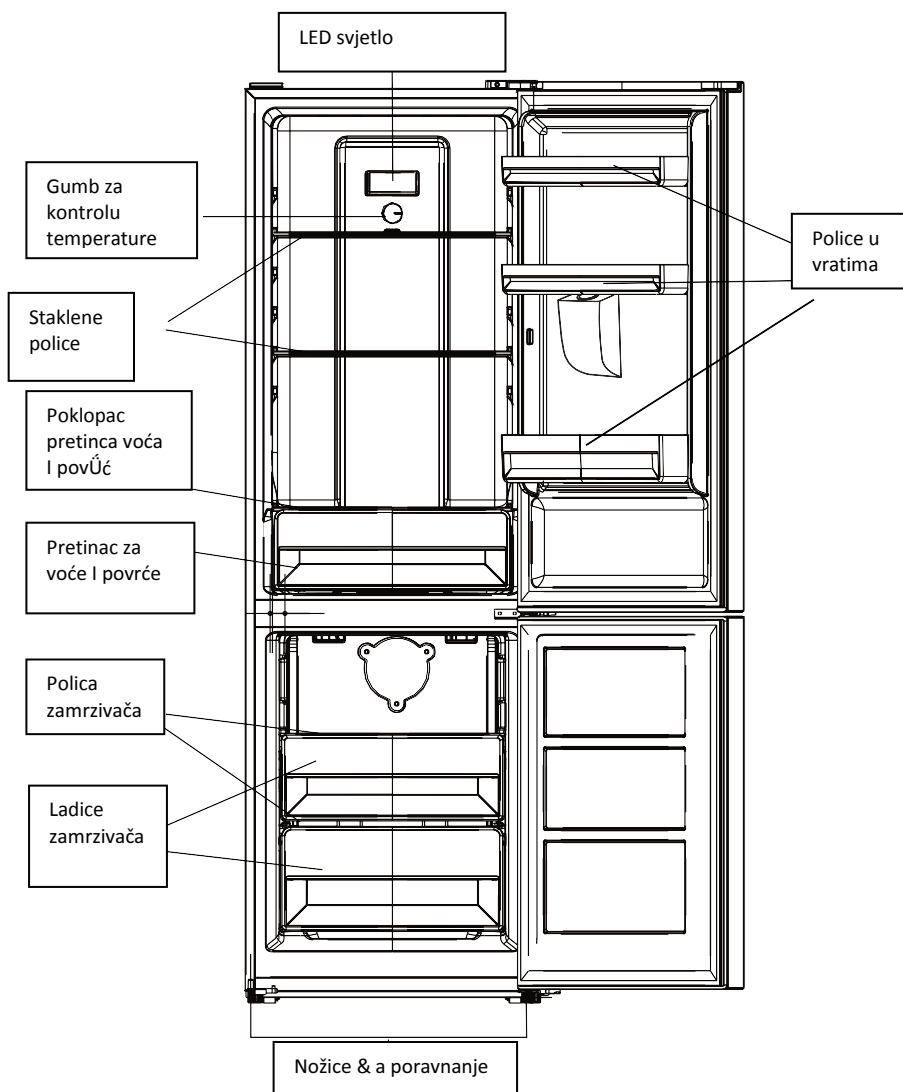

Napomena: Zbog modificiranja naših proizvoda, Vaš hladnjak se može neznatno razlikovati od ovdje prikazanog, ali funkcije i na in i korištenja su isti. Kako biste dobili više mjesta u zamrziva u, možete izvaditi policu.

INSTALACIJA

Instalirajte ručku ako se radi o hladnjaku sa vanjskom ručkom.

Razmak

Ostavite dovoljno prostora za otvaranje vrata.

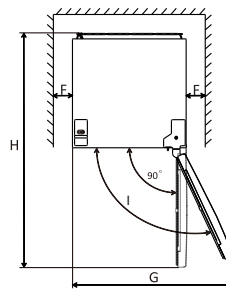
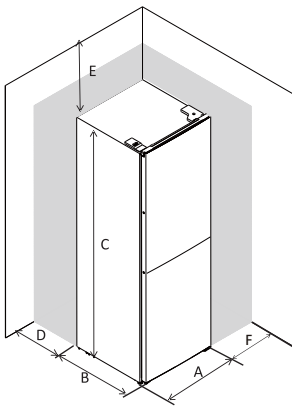
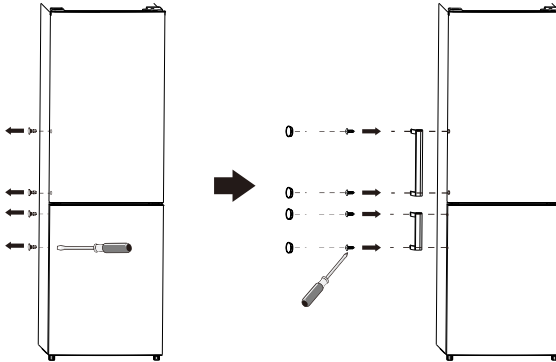

A	600
B	605
C	1860
D	min=50
E	min=50
F	min=50
G	1200
H	1200
I	135°

Niveliranje uređaja

Kod niveliranja podesite nožice uređaja.

Ako uređaj nije ravan, vrata i magnetna brtva neće biti ispravno pokriveni.

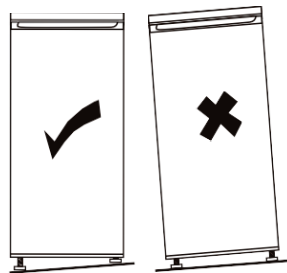
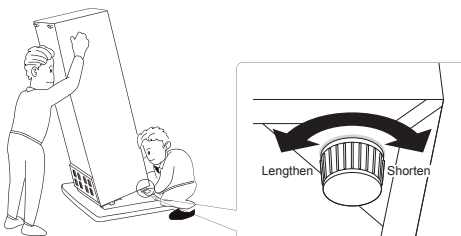

POZICIONIRANJE UREĐAJA

- Izaberite mjesto koje nije direktno izloženo sunčevoj svjetlosti
- Izaberite mjesto koje omogućava lako otvaranje vrata;
- Izaberite mjesto sa ravnim podom
- Ostavite dovoljno prostora za postavljanje hladnjaka
- Prilikom instalacije ostavite slobodni prostora desno i lijevo od uređaja, iza i iznad uređaja. To će smanjiti potrošnju električne energije.
- Ostavite minimalno 50mm gap sa lijeve i desne strane, te iza uređaja.
- Ovaj rashladni uređaj nije namijenjen za uporabu kao ugradbeni uređaj

Pozicioniranje

- Postavite ovaj uređaj na mjesto gdje temperatura okoline odgovara klimatskom razredu navedenom na nazivnoj pločici uređaja:
 - za rashladne uređaje s klimatskim razredom:
- proširena umjerena : ovaj rashladni uređaj namijenjen je uporabi na temperaturama okoline u rasponu od 10 °C do 32 °C;(SN)
- umjereni: ovaj rashladni uređaj namijenjen je uporabi na temperaturama okoline u rasponu od 16 °C do 32 °C;(N)
- subtropski uređaj: ovaj rashladni uređaj namijenjen je uporabi na temperaturama okoline u rasponu od 16 °C do 38 °C;(ST)
- tropical: tropski: ovaj rashladni uređaj namijenjen je uporabi na temperaturama okoline u rasponu od 16 °C do 43 °C;(T)

Instalacija

Uređaj je potrebno instaliran daleko od izvora topline kao što su radijatori, kotlovi, izravna sunčeva svjetlost itd.

Osigurajte da zrak može slobodno cirkulirati oko stražnjeg dijela ormarića. Kako bi se osigurali najbolji rezultati, ako je uređaj postavljen ispod viseće zidne jedinice, minimalna udaljenost između vrha ormara i zidne jedinice mora biti najmanje 100 mm. U idealnom slučaju, uređaj ne smije biti postavljen ispod visećih zidnih jedinica. Točno niveliranje je osigurano jednom ili više podesivih nožica na dnu uređaja.

UPOZORENJE ! Uređaj morat emoći isključiti iz mrežnog napajanja; utikač stoga mora biti lako dostupan nakon instalacije.

Električni priključak

Prije uključivanja provjerite odgovaraju li napon i frekvencija prikazana na nazivnoj pločici vašem kućnom napajanju. Proizvođač odbija svu odgovornost ako se ne poštuju gore navedene sigurnosne mjere opreza.

PROMJENA SMJERA OTVARANJA UREĐAJA

Prije promjene smjera otvaranja vrata pripremite sljedeći alat: ravni odvijač, križni odvijač i ključ

Poklopac šarke lijevor x 1

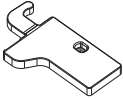

Dio za lijevu gornju stranu vrata x 1

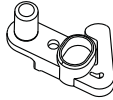

dio za lijevu donju stranu vrata x 1

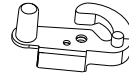

1. Odvijte gornji poklopac šarke i zatim odvrnite gornji zglob.
Pažljivo uklonite gornji poklopac šarke ravnim odvijačem

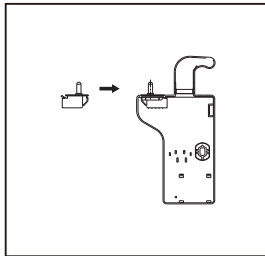
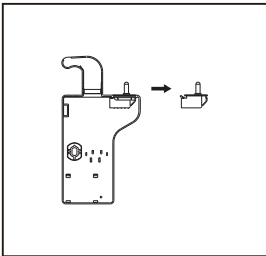
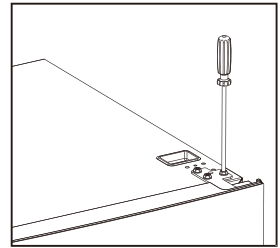
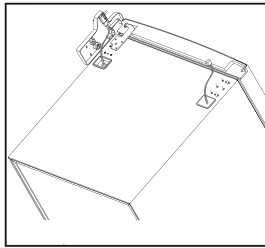
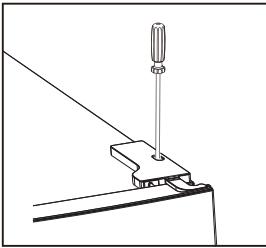

2. Uklonite poklopac otvora ravnim odvijačem.

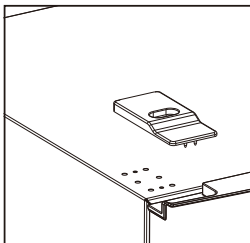
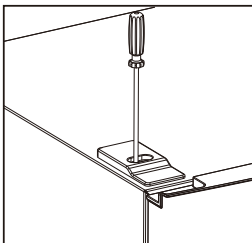

3. Izvadite vijak iz srednje šarke, a zatim skinite donja vrata

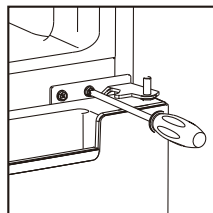

4. Položite hladnjak, izvadite nožice za poravnanje, a zatim križnim odvijačem skinite donju šarku.

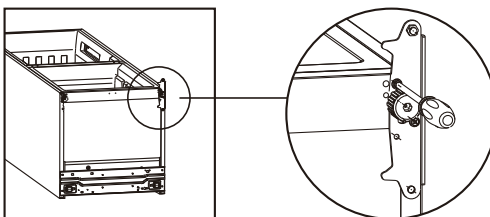

5. Podesite položaj donje i gornje šarke u suprotni položaj.

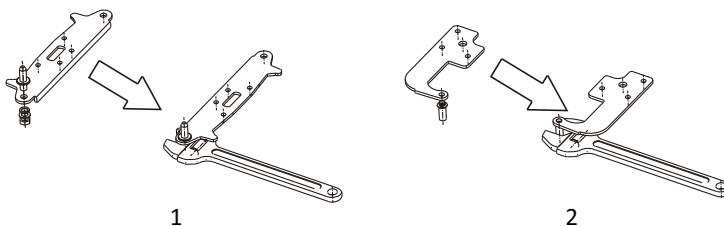

6. Instalirajte donju šarku ispod hladnjaka kao što je prikazano na slici niže okrećući nožice za niveliranje .

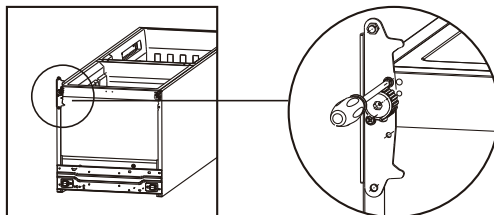

7. Izvadite originalne nosače s gornjih i donjih vrata, a zatim instalirajte pomoćne nosače.

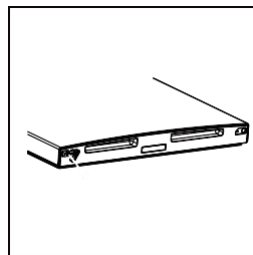
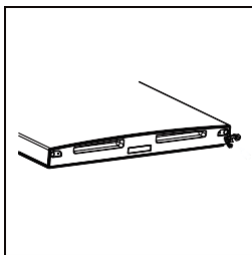

8. Instalirajte donja vrata , namjestite i učvrstite srednju šarku na uređaj.

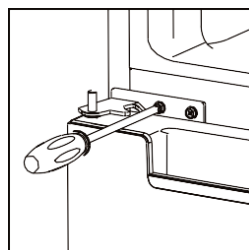

9. Postavite gornja vrata u početni položaj. Osigurajte da su vrata poravnata i vodoravno i okomito tako da se brtve zatvore sa svih strana prije nego što zategnete gornju šarku, azatim gornju šarku pričvrstite za vrh uređaja, te zatim vijkom pričvrstite poklopac šarki (u dodatnoj vrećici).

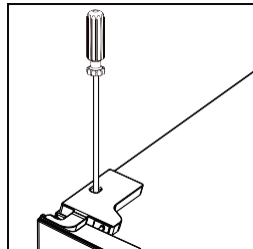
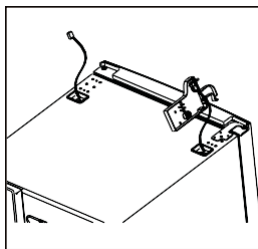
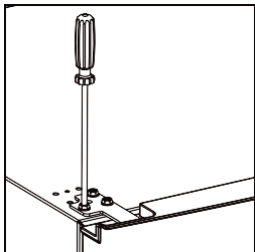

10. Pričvrstite poklopac vijka

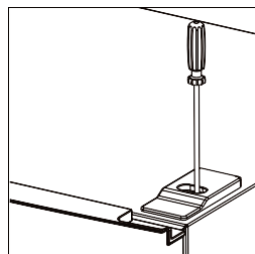

11. Odvojite hladnjak i brtve vrata zamrzivača, a zatim ih pričvrstite nakon okretanja.

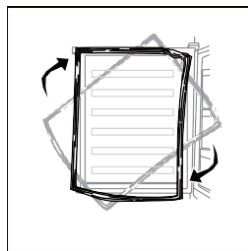

KONTROLNA PLOČA

1. Podešavanje temperature u hladnjaku

Regulator temperature

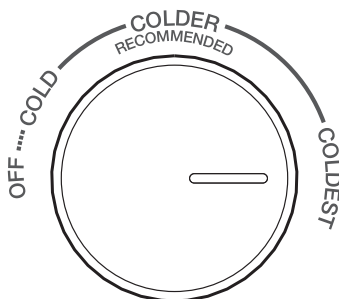

- Regulator temperature koristi se kako bi se podesila temperatura u hladnjaku.
- Unutarnju temperaturu kontrolira sensor, koji ima 4 postavke: OFF (ISKLUČENO), COLD (HLADNO), COLDER (SREDNJE HLADNO) i COLDEST (NAJHLADNIJE).
- Uređaj možda neće raditi na ispravnoj temperaturi ako je posebno vruće ili ako često otvarate vrata hladnjaka.
- Kad je uključena postavka OFF hladnjak i zamrzivač neće raditi.

2. Podešavanje temperature u zamrzivaču



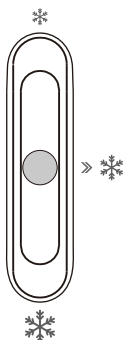

Regulator temperature

FREEZER CONTROL

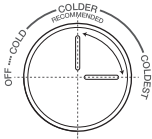

- Klizni regulator temperature koristi se za podešavanje temperature u zamrzivaču.
- Kad je klizni regulator prema ❄️, temperatura u hladnjaku će biti veća.
- Ako regulator pomičete prema ❄️❄️ temperatura će biti niža
- Srednji položaj regulatora ❄️❄️ savjetuje se za normalno korištenje.
- Kako biste smanjili temperaturu u zamrzivaču, pomaknite klizni regulator prema ❄️❄️❄️

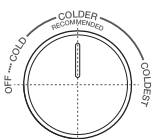
Preporuke temperature

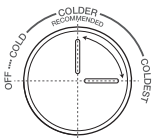
Preporuke za podešavanje temperature			
Temperatura okoline	Zamrzivač		Hladnjak
Ljetne temperature Iznad 38 °C		Set on *	 Hladnije
Standardna		Set on *	 Hladno
Zimske temperature Ispod 16 °C		Set on *	 Najhladnije

- Gornje informacije odnose se na preporučene temperature
- U zimi i ako je temperature ispod 16°C, treba izbjegavati postavke na * i hladnije.
- Za uštedu energije, postavku * i najhladnije podesite samo u posebnim slučajevima (poput brzog smrzavanja ili pravljenje leda)

VAŽNO! Za optimalno konzerviranje hrane općenito je najprikladnije srednje postavljanje. Postavljanje visoke temperature rezultirati će bržim propadanjem hrane.

Prije prve uporabe dispenzera za vodu, uklonite i očistite posudu za vodu koja je smještena unutar hladnjaka.

1. Podignite i uklonite policu posude za vodu.

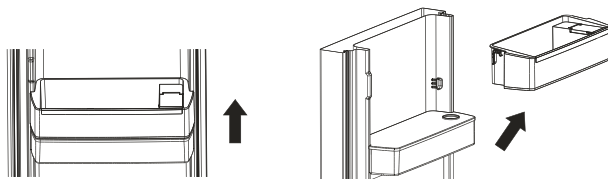

2. Uklonite posudu za vodu. Odvojite poklopac i operite i očistite i poklopac i posudu.

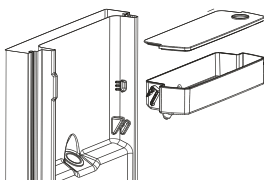

3. Nakon čišćenja, vratite posudu za vodu, poklopac i policu kao što je na slici.:

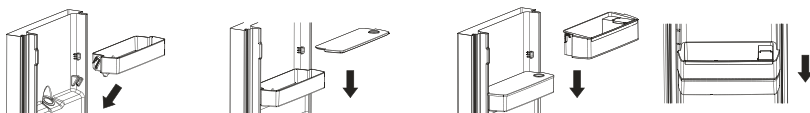

4. Očistite polugu raspršivača na vanjskoj strani vrata hladnjaka.

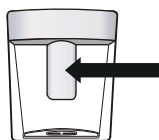

Punjenje posude za vodu

1. Otvorite mali poklopac na vrhu police posude.
2. Napunite posudu za vodu do linije 2L
3. Zatvorite poklopac, budite sigurni da je čvrsto zatvoren.

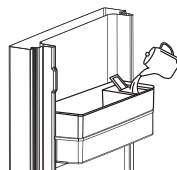

Doziranje vode

Ručicu dozatora lagano pritisnite čašu, kada zaustavite protok vode, odmaknite čašu.



SVAKODNEVNA UPORABA

Prva uporaba

Čišćenje unutrašnjosti uređaja

Prije prve uporabe uređaja operite unutrašnjost i sve unutarnje dodatke mlakom vodom i blagim sapunom kako biste uklonili tipičan miris potpuno novog proizvoda, a zatim temeljito osušite.

VAŽNO! Nemojte koristiti deterdžente ili abrazivne praške jer će to oštetiti uređaj!

Preporučljiv raspored namirnica u hladnjaku:

Odjeljci hladnjaka	Vrsta hrane
Odjeljci na vratima hladnjaka	<ul style="list-style-type: none">• Hrana s prirodnim konzervansima, kao što su džemovi, sokovi, pića, začini.• Nemojte skladištiti pokvarljivu hranu.
Ladica hladnjaka	<ul style="list-style-type: none">• Voće, bilje i povrće treba staviti odvojeno u hrskavu kantu.• Nemojte čuvati banane, luk, krumpir, češnjak u hladnjaku.
Polica hladnjaka – sredina	<ul style="list-style-type: none">• Mliječni proizvodi, jaja
Polica hladnjaka – na vrhu	<ul style="list-style-type: none">• Namirnice koje ne trebaju kuhanje, kao što su gotova hrana, meso delikatesa, ostaci.
Ladice zamrzivača	<ul style="list-style-type: none">• Zamrzavanje, čuvanje smrznutih namirnica

Zamrzavanje svježih namirnica

- Zamrzivač je pogodan za zamrzavanje svježih hrane i čuvanje zamrznute iduboko smrznute hrane dulje vrijeme.
- Stavite svježiju hranu koja će se zamrznuti u zamrzivač.
- Najveća količina hrane koja se može zamrznuti u 24 sata navedena je na nazivnoj pločici.
- Postupak zamrzavanja traje 24 sata, tijekom tog razdoblja ne dodajte drugu hranu koja će se zamrznuti.

Čuvanje zamrznute hrane

Prilikom prvog pokretanja ili nakon razdoblja bez uporabe prije stavljanja proizvoda u odjeljak pustite uređaj da radi najmanje 2 sata na višim postavkama.

Važno! U slučaju slučajnog odmrzavanja, hrana mora biti konzumirana odmah ili kuhana odmah, te se nakon toga može ponovno zamrznuti nakon kuhanja.

Odmrzavanje

Duboko smrznuta hrana ili smrznuta hrana može se odmrznuti u odjeljku hladnjaka ili na sobnoj temperaturi. Mali komadići se mogu kuhati smrznuti. U ovom slučaju kuhanje će trajati duže.

Podesive police

Police u vratima mogu se podesiti na željenu razinu.

Podesive police u vratima

Police u vratima se mogu skinuti za potrebe čišćenja. Kako biste prilagodili visinu policca, povucite policu u smjeru strelice dok se ne oslobodi te zatim namjestite prema potrebi.

Prilagodba policca

1. Izvucite donju ladicu
2. Podignite prvu stranu ladice
3. Izvucite ladicu do kraja.

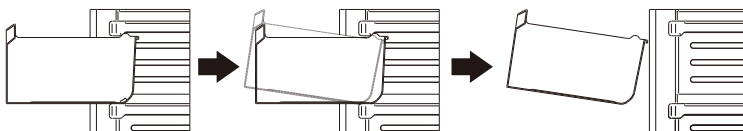
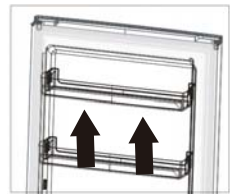
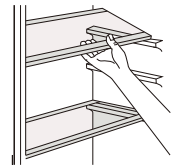

Korisni savjeti i preporuke

Kako biste maksimizirali postupak zamrzavanja slijedite navedene upute:

- Maksimalna količina hrane koja se može zamrznuti u 24 sata nalaz se na pločici uređaja
- Proces zamrzavanja traje 24 sata. Ne preporuča se dodavanje druge hrane.
- Zamrzavajte samo svježje i temeljito očišćene namirnice.
- Pripremite hranu u malim porcijama kako bi se omogućilo njeno brzo i potpuno zamrzavanje
- Zamotajte hranu u aluminijsku foliju ili polietilen i provjerite jesu li paketi nepropusni za zrak
- Ne dozvolite da svježje smrznuta hrana dodiruje smrznutu hranu, čime izbjegavate porast temoerature

- Sol smanjuje vijek spremanja hrane.
- Kockice leda, ako se konzumiraju odmah nakon vađenja iz zamrzivača, mogu uzrokovati ozebline
- Preporučljivo je na svakoj porciji napisati datum zamrzavanja.

Savjeti za spremanje smrznute hrane

- Osigurajte da smrznute prehrambene proizvode soredmate na odgovarajući način
- Osigurajte da smrznutu hranu iz trgovine u što kraćem roku spremite u zamrzivač.
- Ne otvarajte prečesto vrata zamrzivača
- Odmrznutu hranu nemojte više zamrzavati
- Hranu zamrzavajte sukladno preporučenom datumu zamrzavanja na pakiranju

Savjeti za spremanje sveže hrane

- Ne spremajte toplu hranu u hladnjak
- Zamotajte hranu u aluminijsku foliju ili polietilen
- Pridržavajte se roka trajanja namirnica, koji je označen na ambalaži proizvoda
- Pravilna uporaba uređaja, odgovarajuće pakiranje namirnica, održavanje odgovarajuće temperature, i poštovanje osnovnih higijenskih zahtjeva namirnica ima odlučujuću ulogu na kakvoću održavanja namirnica

Čišćenje

Iz higijenskih razloga redovite čistite unutrašnjost uređaja.



Oprez! Upozorenje! Prije čišćenja isključite uređaj iz električne mreže i izvadite priključni kabel iz utičnice. Opasnost od strujnog udara!
Uređaj nikad ne čistite parnim čistačem. Vлага se može akumulirati u električnim komponentama, opasnost od strojnog udara! Vruće pare mogu dovesti do oštećenja plastičnih dijelova. Uređaj mora biti prije uključivanja.

Važno! Eterična ulja i organska otapala mogu oštetiti plastične dijelove. Ne dozvolite da ove supstance dođu u kontakt sa dijelovima uređaja.

Nemojte koristiti abrazivna sredstva za čišćenje
Uklonite hranu iz hladnjaka i odložite na hladno mjesto.
Isključite uređaj iz napajanja.
Očistite uređaj mokrom krpom te ga osušite.
Nakon završetka čišćenja uključite uređaj.

NAPOMENA: Ovaj uređaj nije ugradbeni uređaj.

Zamjena LED lampice

Za zamjenu LED lampice kontaktirajte ovlaštenog servisera.

Otklanjanje kvarova



Upozorenje! Prije rješavanja problema, isključite uređaj iz napajanja. Rješavanje problema koji nisu u ovim Uputama mora odraditi ovlašteno servis.

Važno! Tijekom normalne uporabe čuju se zvukovi (cirkulacija rashladnog plina)

Problem	Mogući uzrok	Rješenje
Uređaj ne radi.	Regulacija temperature je na funkciji "najhladnije"	Postavite regulaciju na drugu funkciju.
	Utikač nije priključen na utičnicu.	Uključite utikač u utičnicu.
	Osigurač je oštećen	Zamjenite osigurač ispravnim.
	Utičnica je oštećena.	Kontaktirajte ovlaštenu osobu kako biste riješili problem.
Uređaj hladi ili zamrzava prebrzo.	Temperatura je podešena na najjače.	Postavite regulaciju temperature na nižu temperaturu.
Hrana nije dovoljno zamrznuta.	Temperatura nije dobro podešena.	Provjerite preporuke podešavanja temperature u ovim Uputama.
	Vrata su bila dugo otvorena,	Otvorajte vrata samo koliko je potrebno.
	U uređaj ste u posljednja 24 sata stavili veliku količinu tople hrane.	Temperaturu privremenu postavite na hladniji stupanj.
	Uređaj se nalazi u blizini izvora topline.	Provjerite poglavlje o pravilnom postavljanju uređaja.
Nakupine leda na gumi vrata	Brtva na vratima nije hermetički zatvorena.	Polagano zagrijte dijelove vrata koji puštaju sušilom za kosu. Istodobno rukom pravilno oblikujte zagrijanu brtvu.
Neobični zvukovi	Uređaj nije dobro postavljen.	Podesite nožice uređaja.
	Aparat dodiruje zid ili neki drugi objekt.	Pomaknite malo uređaj.
	Komponenta, npr. cijev na stražnjoj strani uređaja dodiruje drugi dio uređaja ili zid.	Ako je potrebno maknite komponentu od zida.
Mokar pod	Ovodni otvor je začepljen.	Uklonite objekt koji blokira odvodni otvor.
Bočne strane uređaja su vruće	To je normalno. Izmjena topline odvija se na bočnim stranama.	Stavite rukavice prilikom dodirivanja bočnih strana ukoliko je potrebno.

Ako se problem ponavi, kontaktirajte ovlašteno servis.

Zbrinjavanje uređaja

Ovaj uređaj ne sadrži plinove koji bi mogli oštetiti ozonski omotač, ni u njegovom krugu rashladnog sredstva ili izolacijskim materijalima. Zabranjeno je bacati dotrajali uređaj s kućanskim otpadom. Izolacijska pjena sadrži zapaljive plinove: uređaj se mora odložiti u skladu s propisima o aparatu. Izbjegavajte oštećivanje rashladne jedinice, osobito izmjenjivača topline.

Ambalaža sa simbolom recikliranja se može reciklirati. Zbrinite je u odgovarajućem reciklažnom spremniku.

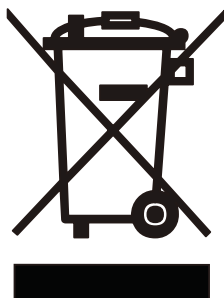

Simbol prekrížene kante za otpad znači da je proizvod potrebno zbrinuti odvojeno od otpada iz kućanstva. Proizvod je potrebno proslijediti na reciklažu u skladu s lokalnim propisima o zaštiti okoliša za zbrinjavanje otpada. Odvajanjem označenog proizvoda od otpada iz kućanstva pomoći ćete u smanjivanju količine otpada poslanog u spalionice ili na deponije i minimizirati potencijalno negativan učinak na zdravlje ljudi i okoliš.

Ambalaža

Ambalaža sa simbolom recikliranja se može reciklirati. Zbrinite je u odgovarajućem reciklažnom spremniku.

Prije zbrinjavanja uređaja

1. Odspojite kabel napajanja.
2. Odrežite kabel napajanja i bacite ga zajedno s utikačem.

Upozorenje! Hladnjaci u izolacijskim materijalima sadrže rashladna sredstva i plinove.

Rashladna sredstva i plinovi moraju se zbrinuti profesionalno jer mogu izazvati ozljede oka i zapaljenja. Prije pravilnog zbrinjavanja provjerite da rashladni sklop nije oštećen.